



**SPARTAN
EQUIPMENT®**

Forestry Mulching Disk



Owner's/Operator's Manual



WARNING

For safe operation, read these rules and instructions carefully to avoid acSpartan Equipments that could result in Death or Serious Injury.

TO THE OWNER/OPERATOR OF THIS IMPLEMENT

Please read this manual "before" unpacking or using this implement for the first time. This manual provides you with the necessary instructions to safely install and use your purchase. Do not let other people use this attachment without first being instructed how to safely use it.

Save this manual for future reference!

Information

Record product information here for future reference.

Model (✓)	
32 - 44 GPM _____	45 - 60 GPM _____
S/N & MFG. Date _____	
Spartan Equipment (888) 888-1085	
Date of Purchase ___/___/_____	

Table of Contents

Information.....	2
Orientation	3
Importance of Safety	3
Operator Safety Training Tips	4
Skid Steer Requirements	5
Unpacking Your Shipment	5
Using Your Implement	5
Connecting Mulcher to Skid Steer... ..	5
Pre-Operation Walk-around	
Inspection.....	6
Mulcher Boom Controls	6
Engaging Mulcher the First Time.. ..	6
Starting the Mulcher	7
Stopping the Mulcher.....	7
Getting Familiar with the	
Attachment	7
Adjusting Cutter Height & Level	8
Before Cutting	8
Cutting Tips	9
Maintaining your Attachment	9
Lubrication Check & Add	10
Before Every Use	10
Every Week	10
After Every Season	10
Disk Removal & Installation.....	10
Teeth Removal & Replacement.. ..	11
Hydraulic System	11
Parts.....	13
Diagram.....	14
Decals	15
Troubleshooting	16
Specifications	17
Warranty	18

Troubleshooting	18
Specifications.....	19
Limited Warranty.....	20

Orientation



Serial Number Plate is Located on Top of Mounting Plate

Importance of Safety

AcSpartan Equipmentents can be very costly to human life and property. As the operator is the #1 safety device on all types of vehicles or equipment, it is important that the operator read, learn and know all safety recommendations for this product. The user is responsible to his family, friends and co-workers to operate in a safe manner. Ensure that everyone who operates or assists in the operation or maintenance of this product read and understand all the elements required to safely operate this piece of equipment.

This attachment has a spinning blade which adds additional danger.

Throughout this manual you will find safety notes which are very important to read and understand before operating this piece of equipment. These classifications alert you to situations that could be harmful to you or bystanders. When you see these alerts in the manual, carefully read and

follow all instructions.

 **DANGER** Will result in Death or Serious Injury.

 **WARNING** Could result in Death or Serious Injury.

 **CAUTION** Could result in Minor or Serious Injury.

 **NOTICE** Not related to Personal Injury.

Operator Safety Training Tips

It is the responsibility of the operator using this attachment to be acquainted with the safe operation. In addition to reading this manual, it is important that the operator read the skid steer's operation manual and follow its manufacturer's recommendations!

 Before lifting or lowering the mulcher, make sure the area is clear of bystanders or objects.

 Machinery parts sometimes have sharp edges. Wear work gloves when moving parts. Always use caution around mulcher teeth as they often are very sharp.

 Never use drugs or alcoholic drinks when operating or servicing this piece of equipment.

 Always wear the proper personal protection equipment when servicing or operating this piece of equipment. Never service or operate this attachment with bare feet, sandals, or other light footwear.

 Always use eye protection during operation. Mount this attachment on a skid steer equipped with thermoplastic polycarbonate door panel and side panels.

 Speed Kills! Operate this implement at a safe working speed. When transporting the implement, keep a safe speed to avoid losing control of the attachment or prime mover.

 Keep proper clearance between the implement and objects (utilities, large rocks, buildings, etc.). Contacting these objects with the implement or prime mover could cause a loss of control or damage to the implement or property.

 Before each operation of this implement, check all hardware (bolts, nuts, pins, etc.) for their proper location and tightness.

 Stop the engine on the skid steer and set the brake to avoid the implement rolling forward or backwards while you are exiting the prime mover.

 Store this implement in an area not frequented by children.

 Allow no riders on this attachment. Keep all bystanders clear of attachment during operation.

 Always replace worn, torn or missing safety decals before operating.

 Never operate the mulcher when bystanders are within 300 feet (91 m) of the work area.

 Cut only during daylight or well-lit artificial light

Skid Steer Requirements

Your forestry mulching disk should only be used on a skid steer with a lift capacity of at least 3,000 lbs. and with a weight of at least 10,000 lbs. with the bucket removed. A skid steer equipped with tracks will provide superior stability in this application.

The range of flow available in the high flow setting of your skid steer loader may determine which model Forestry mulching disk motor will work best.

To protect the operator from any flying debris, it is important that the skid steer should be equipped with a thermoplastic polycarbonate windshield or similar material, and similar protection on the sides of the operator's cab.

 **CAUTION** Make sure your skid steer is in good working condition. Follow the operating instructions found in the manual that accompanied your skid steer. Failure to do so could result in Minor or Serious Injury.

Unpacking Your Shipment

Your attachment arrives from the factory banded to a wooden pallet, and requires no final assembly before use.

 **CAUTION** Careless removal of the shipping bands that secure the implement to the pallet could result in Minor or Serious Injury. Clear the area of all bystanders and

stand to the side when cutting the bands with a pair of sheet metal shears.

Using Your Implement

Connecting Mulcher to Skid Steer

 **DANGER** *Never enter the area underneath the coupler or any part of the attachment when it is in the raised position to avoid an acSpartan Equipment that will result in Death or Serious Injury.*

Verify that the hydraulic hoses are clear from the front of the attaching plate on the attachment and that the mounting plate is free from dirt and debris. When clear, move the skid steer to proximity of attachment plate.

Tilt skid steer coupler forward to align coupling point with the upper part on the attachment plate and raise the coupler slightly.

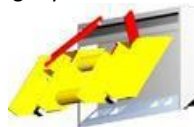

Connecting Coupler to Attachment

When the top edge of the coupler is seated in the top part of the coupler plate, roll the skid steer tilt function back until the attaching plate is flat against the skid steer coupler. Lock down the coupler levers. Note: If your skid steer is equipped with a hydraulically operated coupler, activate the coupler lock at this time.



NOTICE Wipe off any dirt or dust from the male or female hydraulic flat-face couplers with a clean rag before attaching hoses, to keep contaminants from entering the hydraulic system.

NOTICE Never operate this mulcher without the case drain hose connected to the case drain circuit on the prime mover.

Connect the attachment hydraulic hoses to the auxiliary supply couplers located on your skid steer loader lift arm.

Check the surrounding area for bystanders and clear them before starting the skid steer or attachment.

Before operating the attachment, always visually inspect and verify that the coupler lock pins are fully engaged through the latch slots on the attachment plate.

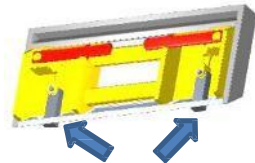

Check Coupler Lock Engagement

Pre-Operation Walk-around Inspection

Before every use, it is important to perform a short inspection and certain maintenance on your mulcher.

	Item
✓	Check that all shields and guards are in place.

✓	Look for loose bolts and tighten them if necessary.
✓	Check that all safety decals are in place and can be read. Replace them if necessary.
✓	Refer to disk manual regarding safety checks and maintenance of blade and teeth.
✓	Take care of our environment. Repair any hydraulic leaks.

Mulcher Boom Controls

Your forestry mulcher is designed to run off the skid steer loaders auxiliary hydraulic system, and is activated and deactivated by a control in the operator's cab. Consult your skid steer operator's manual for precise instructions on how to activate and deactivate the auxiliary circuit.

Height and tilt functions of the mulcher are operated with the control handles or pedals in the cab. Consult your skid steers operator's manual for precise instructions regarding these functions.

Engaging Mulcher the First Time

NOTICE If this is your initial startup with this attachment on this machine, check the skid steer's hydraulic oil level and add oil, if necessary, before and after doing steps 1- 3 below.

NOTICE Make sure the case drain hose is properly attached to the prime mover's case drain connection. Do not operate this attachment without the case drain hose attached.

After starting skid steer, lift the attachment 6" (152mm) off the ground surface:

1. With the skid steer engine RPMs just above idle, slowly engage the auxiliary hydraulic flow to the mulcher. Use your machine's auxiliary hydraulic flow lever or switch, activate the auxiliary flow to the mulcher.
2. Allow the mulcher to run for 30 seconds to purge the air from the system. Ensure that the rotation is correct. Turn off the mulcher drive, allowing it to come to a complete stop.
3. Lower the mulcher attachment to the ground and shut off the skid steer's engine and exit the operator's compartment.
4. Check the skid steers hydraulic oil level, and add oil if necessary.
5. Inspect the hydraulic plumbing for any noticeable leaks. Correct these leaks before continuing.
6. Restart the skid steer. With the attachment raised off the ground and the engine throttle set just above idle, engage the drive circuit. Allow mulcher to speed up before increasing flow. **Starting the**

Mulcher

 WARNING *Moving or engaging the mulcher with bystanders in the area could result in Death or Serious Injury. Before engaging mulcher hydraulics, always make sure the area is clear of bystanders.*

Engage the mulcher drive hydraulics with the prime mover's engine at a low rpm. Slowly raise the skid steer engine's rpm to the correct and desired speed. Use the skid steer's hand throttle to set the speed; never use a foot throttle when using the mulcher.

 NOTICE **If the mulcher ever creates a vibration when ramping up speed, turn the mulcher attachment to the off position and investigate cause. Refer to the troubleshooting section in this manual.**

Stopping the Mulcher

When stopping the mulcher, raise the mulcher slightly and lower the skid steer's engine RPMs to an idle, and allow the mulcher to slow down. After the mulcher has slowed down you may turn the auxiliary hydraulics to the "off" position.

Getting Familiar with the Attachment

 DANGER **Never operate the mulcher when bystanders are within 300' (91 m) of your work area. Flying debris could result in Death or Serious Injury.**

 CAUTION **Be cautious when operating on un-level ground surfaces. A machine roll over could result in Minor or Serious Injury. Always wear your seat belt when operating this type of machinery.**

Before starting the skid steer engine with this mulcher attached, make sure you are knowledgeable and comfortable with the operation of the mulcher controls as outlined in the previous and following sections of this manual.

When operating the mulcher, set the skid steer throttle at a speed that will produce the required flow. Refer to your skid steer manual or call your local skid steer dealer for additional help, if necessary. Your skid steer dealer can measure the flow available on your machine and recommend a

throttle setting that is compatible with this attachment.

To begin with, learn what the mulcher deck looks like in a level cutting position when you are seated in the skid steer. Knowing what a level mulcher looks like will help you avoid damage to the cutting teeth and disk by cutting too close to the ground surface.

The correct ground speed for cutting with this attachment can be monitored by sound and feel and depends on the material density. If the skid steer engine is bogging down or if the mulcher speed is turning too slow because of too much load, the ground speed should be decreased.

Listen and feel for any strange vibration when working the mulcher. A bad vibration felt when mulching could indicate a damaged disk, or material trying to be cut at too fast a pace. Slow down the skid steers ground speed to see if vibration stops. If it does not, stop the mulcher, turn off the skid steer engine and investigate cause of vibration. Refer to the troubleshooting section in this manual for further instructions.

Always be aware of your surroundings. While watching the mulcher, also pay attention to what obstacles or terrain are in front of the mulcher and prime mover's wheels. Maintain a safe speed while cutting.

⚠ CAUTION Cutting tree branches with the mulcher in an elevated position could result in Death or Serious Injury if the skid steer becomes unstable. Never raise the cutter more a few feet off the ground without extreme caution.

Adjusting Cutter Height & Level

Use the skid steer loader lift to adjust the elevation of the mulcher. The fore & aft leveling can be accomplished by using the skid steer's attachment tilt cylinders.

NOTICE When cutting dense or heavy material, you may want to adjust the level of the mulcher deck. Keeping the front of the deck raised slightly, while cutting small trees will allow for a good feed of material. For larger trees, cutting the top out then vertically mulching is recommended.

⚠ CAUTION Use care when operating on uneven terrain or any type of sloped surface. Raising your mulcher high will increase chances of a roll over that could result in Minor or Serious Injury.

Before Cutting

Inspect the area to be cut and make sure it is free of any utilities, rocks, fence posts, or any other objects that you do not want to cut or that would damage the mulcher.

Determine a safe cutting pattern before the start of the cut. Stop the forward progress of the skid steer loader.

Do not enter into an area to be cut before the mulcher rotation come up to the operating speed.

Cutting Tips

⚠ CAUTION Never operate this attachment when bystanders are in proximity of the work area, this could result in Minor or Serious Injury from flying debris.

1. Always inspect work area before starting the mulcher. Locate and mark any utilities, steel posts, rocks or any other objects that could be damaged or would damage the mulcher during operation. Never assume the work area is safe and never skip the inspection before the start of operation.
2. Operate at a safe comfortable pace that will allow you to watch the area ahead of the mulcher & loader.
3. Make sure you are operating the skid steer's engine at an rpm that will produce the volume of oil flow required for this attachment.

Cutting Ground Level Vegetation

4. Raise the rear of the brush cutter approximately 4" (102 mm) above ground level. Tilting the front of the attachment up while cutting results in a good feed.
5. Your mulcher is capable of cutting and mulching small trees and other vegetation of up to 5" (127mm) in diameter while cutting at the bottom and feeding material on top of the disk. Anything bigger should be vertically mulched with the bottom of the disk.

⚠ CAUTION Do not operate the mulcher if you (the operator) can see

the disk. If the operator can see the disk, the back of the cutter is raised TOO HIGH and should be lowered to avoid debris being thrown back at the operator and causing Minor or Serious Injury.

Cutting Above Ground Level Vegetation

6. Tilt the front of the deck slightly above the rear and drive into the trees near their base, as the trees are being cut tilt the front slightly more to allow a feed of material above the disk. The trees will be pulled into the center of the deck and the chips will be shot out of the other side. Back drag the mulcher to perform the finish work, removing remaining branches and debris.
7. If the disk speed slows down, reduced your travel speed and allow mulcher to reach the proper rotating speed. Mulching too quickly in thick material could result in jamming the disk. If the disk completely stops, stop flow and use a tree to rotate the blade and work the jammed material out. This can be accomplished by placing the outside edge tooth on the tree then turning the skid steer so the disk turns opposite of its cutting direction to bring the jammed material back out the feed side.
8. Never use your mulcher to push, pull, lift or move any type of object or vehicle. Do not use this attachment to "push" down trees without the mulcher being used.
9. Always allow mulcher to come up to operating speed before moving attachment into the material you wish to cut.

Maintaining your Attachment

Lubrication Check & Add

The use and maintenance of proper lubrication is critical to the successful operation and performance of the engineered bearing housing.

Level the attachment. Remove the motor from the gear box. If oil level is low, add ISO 150 EP gear oil lubricant to the housing until the gearbox is filled. Reattach motor to gearbox. For seasonal oil change, while motor is off of gear box, tilt attachment to drain oil out of gear box or siphon oil out. Refill to proper level when emptied and reattach motor.

Before Every Use

Check that all fasteners (nuts, bolts, pins, keepers) are in their right place and are tight.

Inspect and replace any worn, torn or missing safety decals.

Investigate the location of any oil leaks and repair.

Every Week

Check the condition of the teeth by raising the attachment off the ground and tilt the attachment forward to the 90° position. Lower the attachment to the ground.

Sharp teeth will cut more efficiently than dull ones.

After Every Season

Inspect the implement for any loose or worn parts that may need to be replaced prior to the next mulching season.

The gearbox oil should be changed every 2500 operating hours, old oil should be drained and measured, and the same amount of new oil

should then be refilled. The bearings should be greased every time the oil is changed. Use a grease gun to fill cavity until it is full.

The disk assembly should be disassembled and inspected every 1000 operating hours or sooner, refer to disk manual for proper maintenance and safety checks.

Visually inspect the teeth and disk as described in manual.

Clean, sand & repaint any area that looks worn or scratched to prevent further rusting. Use an equipment-paint found at your local hardware store or building center.

Store your implement in a shed or cover with a water-proof tarp to protect it from the weather. Store in an area not frequented by children.

Disk Removal & Installation

Refer to the disc assembly manual for proper removal and installation of saw disk.

⚠ CAUTION Be cautious during the steps detailed. The blade cutter could fall resulting in Minor or Serious Injury. Stand to the side.

NOTICE Use a hoist, power

jack or forklift to support the blade holder during installation

Teeth Removal & Replacement

CAUTION Teeth can be very sharp and could cause Minor or Serious Injury if mishandled. Always wear protective gloves and footwear.

WARNING To avoid an acSpartan Equipmentent that could result in Death or Serious Injury, never find yourself in a position where any body part is located under an unsupported cutter deck when servicing this attachment.

Refer to the disk manual for proper removal and installation of teeth. Be sure to follow torque specs detailed in the manual. Inspection methods are also included in the manual.

Hydraulic System



WARNING A small stream of oil from a pinhole leak could penetrate your skin if contacted. To avoid an acSpartan Equipmentent that could result in Death or Serious Injury, never use your hand or other body parts in an attempt to locate a hydraulic leak.

NOTICE Always release the hydraulic system pressure from the mulcher circuit prior to removing the attachment or any hydraulic system service work.

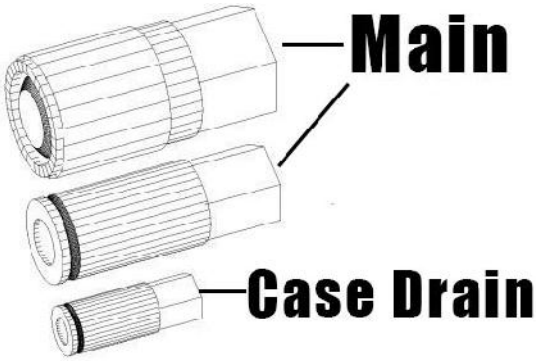
NOTICE Make sure the case drain hose is properly attached to the prime mover's case drain connection. Do not operate this attachment without the case drain hose attached and connected to the skid steer case drain circuit.



Hardware Torque

	Grade 2 lb-ft 	Grade 5 lb-ft 	Grade 8 lb-ft 
1/4"	66*	8	12
5/16"	10	17	20
3/8"	20	30	45
1/2"	45	75	110
3/4"	160	260	380
7/8"	190	400	600
1"	-	580	900

* = inch pounds

Higher torques may require the use of a torque multiplier. All values are "dry" torques.

Parts

When requiring any parts for your implement, please collect the following information:

Implement Model Number
Implement Serial Number
Parts Manual Date (lower right corner)
Parts Manual Page
Part Description
Quantity Required
Ship-to Name & Address
Payment Method

Call (888) 888-1085 for OEM parts specifically designed for your attachment.

**Use Genuine Parts from
Spartan Equipment**

Forestry Mulching Disk Parts

Cutter Deck Shown
Transparent for
Clarity

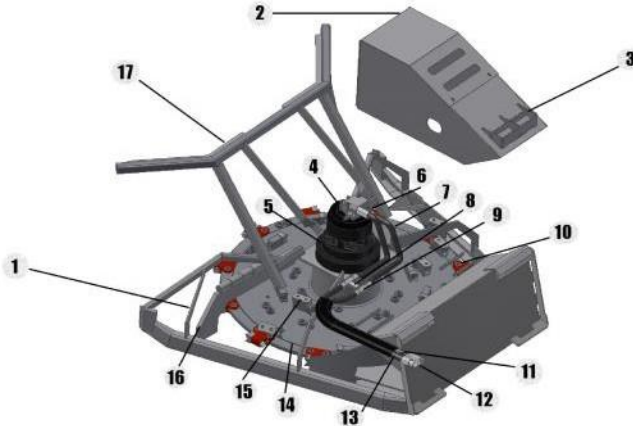

Specify GPM requirements when ordering parts

Ref	Description	Quantity
1	Deck Weldment (deck and sides invisible)	1
2	Motor Cover Assembly	1
3	Motor Cover Step	1
4	Motor	1
5	Gearbox	1
6	Adapter (Motor Case Drain to Case Drain Hose)	1
	Hose, Case Drain	1
	Quick Disconnect (Case Drain)	1
7	Hose (Motor to Tee)	2
8	Tee	2
9	Check Valve	1
10	Deck Grip Strips	4
11	Hose (Check valve to Quick Disconnect)	2
12	Quick Disconnect set (Main)	3
13	Hose (Tee to Quick Disconnect)	2
14	Mulching Disk	1
15	Deck Mounted Teeth	5
16	Deflector	1
17	Pusher Bar Assembly	1

Decals

1 **/// DANGER STAY BACK ///**



**Idle Engine before
shutting down cutter**

**Do not reverse
hydraulic flow to cutter
while operating**

**MUST READ
OPERATOR MANUAL
MUST READ
OPERATOR MANUAL
MUST READ
OPERATOR MANUAL
MUST READ
OPERATOR MANUAL
MUST READ
OPERATOR MANUAL**

PLEASE NOTE:
Attachment and Machine-
side Couplings must be
**FREE OF DEBRIS
BEFORE INSTALLING.**
Failure to comply will void
warranty.

Ref.	Description	Qty.
1*	Decal, (Danger Stay Back)	2
2*	Decal, (Danger Pinch Points)	2
3*	Decal, (Warning, High Pressure Fluid Hazard)	1
4*	Decal, (Warning, Do Not Exceed 27, 35 or 48 GPM) (Note: Select proper decal for your model)	1
5	Decal, Idle Engine Before Disengaging Cutter	1
6	Decal, Must Read Operator Manual	1
7	Decal, Made in the USA	1
8	Decal, Registration & Warranty Info	1
9	Decal, Clean debris from hydraulic couplings	1

*** **WARNING** Replace any worn, torn or missing safety decals before operating!**

Troubleshooting

Problem	Cause	Resolution
Mulcher bogs down	Deck is not properly leveled & material is balling under deck	Refer to leveling instructions found in this manual.
	Dull Teeth	Refer to cutting disk manual.
	Ground speed too fast	Slow down ground speed.
	Mulcher speed too slow	Raise engine RPMs or investigate other low oil flow problem
Vibration felt when running mulcher	Missing, loose, damaged or unbalanced cutting disk	Replace teeth with new or re-sharpened and equally balanced teeth.
	Damaged disk	Refer to disk manual
	Gearbox loose on deck	Tighten & torque gearbox mounting bolts. Replace bolts if they are damaged.
	Cutting height too low for cutting in sandy or rocky soils	Raise mulcher height.
Teeth get dull too quickly	Teeth have contacted solid objects (rocks, steel pipes, etc.)	Clear cutting area of solid objects before hitting them, or raise the cutter height to clear exposed rock surfaces.
Teeth breaking	Excessive shock loads	Avoid hitting solid objects (rock, steel pipes, large tree stumps, etc.).
Hydraulic oil level goes down during operation	Leak at mulcher motor or other plumbing	Investigate & repair
	Leaks in skid steer hydraulic system	Investigate & repair
	Motor seal leak	Cutter run without case drain connected to skid steer.
Disk does not spin when flow is activated	No oil flow	Confirm that quick disconnects are fully seated in their mating connector. Check that skid steer auxiliary circuit is activating.
	Motor or drive shaft failed	Call your dealer for further recommendations.

Specifications

Spec	Model	
	Forestry Mulching Disk 32-44	Forestry Mulching Disk 45-60
Cutting Width	60" (1524 mm)	
Weight (Deck and Blade)	2468 lbs. (1120 kg)	
Cutting Capacity (On top of disk)	5" (127 mm)	
Cutting disk Weight	940 lbs. (426 kg)	
Min SSL Weight	10000 lbs (4536 kg)	
Min SSL Power	90 HP (67 KW)	
Min Hyd. Flow	32 GPM (121 L/min)	45 GPM (170 L/min)
Max Hyd. Flow	44 GPM (166.5 L/min)	60 GPM (227 L/min)
Lubrication	ISO 150 EP	
Warranty	12 Months	

Limited Warranty

Spartan Equipment, Inc. products are warranted to be free from defects in workmanship or materials for period of (12) months from initial sale, lease or rental date.

Warranty Exclusions

This warranty does not cover normal wear items, including but not limited to, bearings, hoses, ground engaging parts such as, teeth, blades, cutting edges, pilot bits, auger teeth and broom bristles. This warranty does not cover maintenance, service or adjustments. This warranty does not cover damage due to misuse, negligence, Spartan Equipment, or improper maintenance. This warranty does not cover damage due to improper application, installation, contamination, adjustment or setup. This warranty does not cover improper modifications of product. This warranty is void if any components have been disassembled, i.e. pumps, gear boxes, motors.

Warranty Statement

Our obligation under this Limited Warranty shall be solely limited to repairing or replacing any part (see non-covered items) free of charge that, according to our judgment, show evidence of a defect in quality of workmanship or materials for the stated (12) month warranty period. All defective parts must be routed directly to SPARTAN EQUIPMENT, Inc. with freight or delivery charges to be prepaid. This Limited Warranty shall not be interpreted to render SPARTAN EQUIPMENT liable for any injury or damage to persons, business or property of any kind nor expenses or losses incurred for labor, supplies, substitute machinery rental, or for any other reason. Repair or replacement parts are subject to the supply conditions at the time of repair or replacements, which may directly affect our ability to obtain material and/or replacements parts. SPARTAN EQUIPMENT reserves the right to make improvements in design or changes in specifications at any time without incurring any obligations to owners of previously purchased units. No one but SPARTAN EQUIPMENT is allowed to alter, modify or enlarge this warranty nor the exclusions, limitation and reservation at any time.